



 **KIRSCH**[®]
DRAPERY HARDWARE

Wrought Iron



SPARKED BY TRADITION

WROUGHT IRON: FOR LOVERS OF OLD WORLD TRADITION

Real Wrought Iron is sand casted
by skilled iron workers.

Time-honored methods and designs.

Hand finished so all unique textures
and qualities are showcased.

Our skilled iron workers still use the time-honored methods to form classic, heavyweight wrought iron products, while protecting the authenticity of the craft and keeping the timeless practice of this beautiful tradition alive. We are proud to keep this remarkable custom alive with the Kirsch Wrought Iron Collection.



CONTENTS

06	Overview
08	1" Finials & Components
18	1 3/8" Finials & Components
28	Helpful Guides
28	AMP™ Motorization
30	Estate™ Overview
32	Bracket Spacing & Mount Option
35	Calculating Drapery Weight
36	Stack Guides
41	Pole Installation, Cutting & Splicing
42	Index



COLLECTION OVERVIEW

6

FINISHES

An alluring range of metals

2

VERSATILE SIZES

1" & 1 $\frac{3}{8}$ "

1

ESTATE™ TRAVERSE ROD SIZES

1 $\frac{3}{8}$ "

1

REMARKABLE COLLECTION

ARCHITRAC™ K-RAIL COMPATIBLE

1 $\frac{3}{8}$ " finials only

AMP™ MOTORIZATION COMPATIBLE

Estate™ Traverse Rods only



2



3

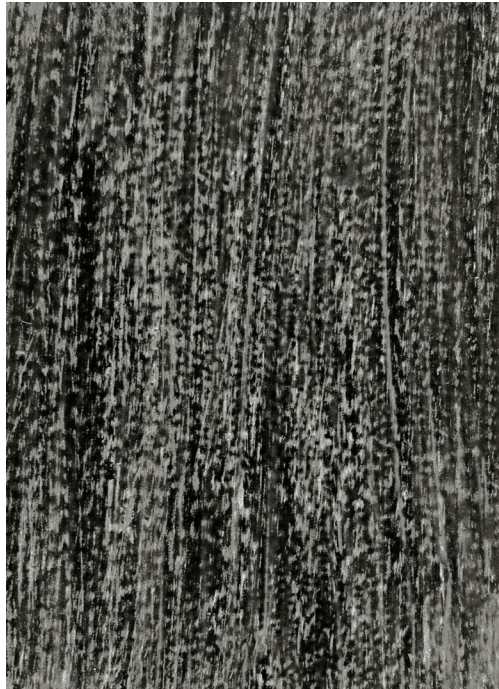

4

- 1 | Black
- 2 | Iron Oxide
- 3 | Rust
- 4 | Graphite | **NEW**
- 5 | Chalk | **NEW**
- 6 | Heirloom Copper | **NEW**

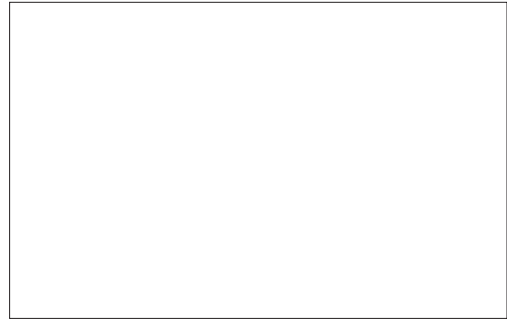

5



6

1" Finials & Endcaps

Axiom

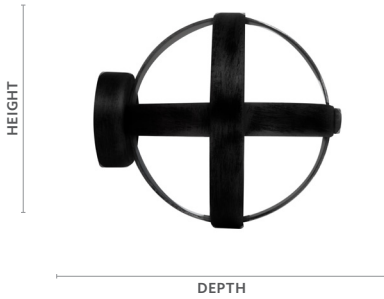

Fits	Dimensions	Quantity per Box
1" Wrought Iron Poles	Depth: 3¼" Height: 2⅞" Width: 2⅞"	5 pairs per box

Product Number & Finish					
56381770	Black	56381804	Graphite	56381802	Iron Oxide
56381803	Chalk	56381805	Heirloom Copper	56381777	Rust

Finial Plugs included.

Darby



Fits	Dimensions	Quantity per Box
1" Wrought Iron Poles	Depth: 2⅞" Height: 1½" Width: 1½"	5 pairs per box

Product Number & Finish					
56384770	Black	56384804	Graphite	56384802	Iron Oxide
56384803	Chalk	56384805	Heirloom Copper	56384777	Rust

Finial Plugs included.

Lincoln



Fits	Dimensions	Quantity per Box
1" Wrought Iron Poles	Depth: 2¼" Height: 1⅞" Width: 1⅞"	5 pairs per box

Product Number & Finish					
56383770	Black	56383804	Graphite	56383802	Iron Oxide
56383803	Chalk	56383805	Heirloom Copper	56383777	Rust

Finial Plugs included.

Otto



Fits	Dimensions	Quantity per Box
1" Wrought Iron Poles	Depth: 2⅞" Height: 2⅞" Width: 2⅞"	5 pairs per box

Product Number & Finish					
56382770	Black	56382804	Graphite	56382802	Iron Oxide
56382803	Chalk	56382805	Heirloom Copper	56382777	Rust

Finial Plugs included.



Otto | Black
Lincoln | Chalk
Darby | Heirloom Copper

1" Finials & Endcaps

Pedestal Ball



Fits	Dimensions	Quantity per Box
1" Wrought Iron Poles	Depth: 4 $\frac{1}{8}$ " Height: 2 $\frac{7}{8}$ " Width: 2 $\frac{7}{8}$ "	5 pairs per box

Product Number & Finish					
56351770	Black	56351804	Graphite	56351802	Iron Oxide
56351803	Chalk	56351805	Heirloom Copper	56351777	Rust

Finial Plugs included.

Petite Faucet



Fits	Dimensions	Quantity per Box
1" Wrought Iron Poles	Depth: 1 $\frac{3}{4}$ " Height: 1 $\frac{3}{4}$ " Width: 1 $\frac{3}{4}$ "	5 pairs per box

Product Number & Finish					
56374770	Black	56374804	Graphite	56374802	Iron Oxide
56374803	Chalk	56374805	Heirloom Copper	56374777	Rust

Finial Plugs included.



1 $\frac{3}{8}$ " Otto | Black
1" Otto | Rust

1" Finials & Endcaps

Petite Modern Ball



Fits	Dimensions	Quantity per Box
1" Wrought Iron Poles	Depth: 2" Height: 1¾" Width: 1¾"	5 pairs per box

Product Number & Finish					
56373770	Black	56373804	Graphite	56373802	Iron Oxide
56373803	Chalk	56373805	Heirloom Copper	56373777	Rust

Finial Plugs included.

Ponce

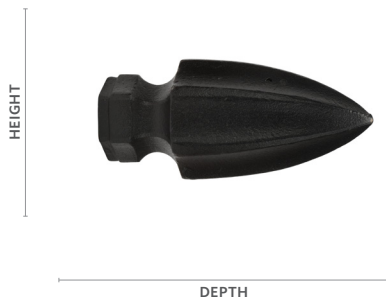

Fits	Dimensions	Quantity per Box
1" Wrought Iron Poles	Depth: 4 ¹³ / ₁₆ " Height: 1½" Width: 1½"	5 pairs per box

Product Number & Finish					
56385770	Black	56385804	Graphite	56385802	Iron Oxide
56385803	Chalk	56385805	Heirloom Copper	56385777	Rust

Finial Plugs included.

Endcap



Fits	Dimensions	Quantity per Box
1" Wrought Iron Poles	Depth: 7/8" Height: 1 1/8" Width: 1 1/8"	5 pairs per box

Product Number & Finish					
56358770	Black	56358804	Graphite	56358802	Iron Oxide
56358803	Chalk	56358805	Heirloom Copper	56358777	Rust

Finial Plugs included.

1" Poles

6' Pole



Diameter	Length	Quantity per Box
1"	6'	6 pieces per box

Product Number & Finish

56359770	Black	56359804	Graphite	56359802	Iron Oxide
56359803	Chalk	56359805	Heirloom Copper	56359777	Rust

8' Pole



Diameter	Length	Quantity per Box
1"	8'	6 pieces per box

Product Number & Finish

56360770	Black	56360804	Graphite	56360802	Iron Oxide
56360803	Chalk	56360805	Heirloom Copper	56360777	Rust

1" Rings

Ring



Fits		Dimensions		Quantity per Box	
1" Wrought Iron Poles		Internal: 1½" External: 2½" External to eyelet: 2¾"		10 bags per box - 7 rings per bag	
Product Number & Finish					
56361770	Black	56361804	Graphite	56361802	Iron Oxide
56361803	Chalk	56361805	Heirloom Copper	56361777	Rust

Bypass C-Ring



Fits		Dimensions		Quantity per Box	
1" Wrought Iron Poles		Internal: 1½" External: 2½" External to eyelet: 2¾"		10 bags per box - 7 rings per bag	
Product Number & Finish					
56371770	Black	56371804	Graphite	56371802	Iron Oxide
56371803	Chalk	56371805	Heirloom Copper	56371777	Rust

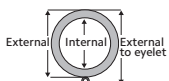

Use the measurement guide to the left to help determine the correct dimensions for your selected product.

1" Brackets

3½" Return Bracket



Fits	Dimensions		Quantity per Box
1" Wrought Iron Poles	Depth: 4¼" Height: 4" Width: ⅝"	Wall to Pole: 3" Return: 3½"	5 pieces per box

Product Number & Finish					
56362770	Black	56362804	Graphite	56362802	Iron Oxide
56362803	Chalk	56362805	Heirloom Copper	56362777	Rust

5⅜" Return Bracket



Fits	Dimensions		Quantity per Box
1" Wrought Iron Poles	Depth: 6¼" Height: 4¼" Width: ⅝"	Wall to Pole: 4⅞" Return: 5⅜"	5 pieces per box

Product Number & Finish					
56363770	Black	56363804	Graphite	56363802	Iron Oxide
56363803	Chalk	56363805	Heirloom Copper	56363777	Rust

3⅝" Center Bypass Bracket



Fits	Dimensions		Quantity per Box
1" Wrought Iron Poles	Depth: 4¼" Height: 4" Width: ⅝"	Wall to Pole: 3½" Return: 3⅝"	5 pieces per box

Product Number & Finish					
56372770	Black	56372804	Graphite	56372802	Iron Oxide
56372803	Chalk	56372805	Heirloom Copper	56372777	Rust

Double Bracket



Fits	Dimensions		Quantity per Box
1" Wrought Iron Poles	Depth: 7½" Height: 5⅝" Width: ⅝"	Wall to Pole: 3" Inner Return: 3½" Outer Return: 6½"	5 pieces per box

Product Number & Finish					
56365770	Black	56365804	Graphite	56365802	Iron Oxide
56365803	Chalk	56365805	Heirloom Copper	56365777	Rust

1" Brackets, Accessories & Components

Inside Mount Socket



Fits	Dimensions	Quantity per Box
1" Wrought Iron Poles	Depth: 1" Height: 2" Width: 2"	5 pairs per box

Product Number & Finish					
56370770	Black	56370804	Graphite	56370802	Iron Oxide
56370803	Chalk	56370805	Heirloom Copper	56370805	Rust

Mounts a 1" rod between two facing walls.

Swivel Socket



Fits	Dimensions	Quantity per Box
1" Wrought Iron Poles	Partial Length: 1½" Plug Length: ¾" Full Length: 2½"	5 pieces per box

Product Number & Finish					
56367770	Black	56367804	Graphite	56367802	Iron Oxide
56367803	Chalk	56367805	Heirloom Copper	56367777	Rust

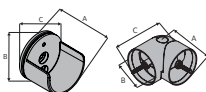

Use the measurement guide to the left to help determine the correct dimensions for your selected product.

1" Accessories & Components

36" Baton with Bypass C-Ring



Fits		Dimensions		Quantity per Box	
1" Wrought Iron Poles		36" long		6 pieces per box	
Product Number & Finish					
56375770	Black	56375804	Graphite	56375802	Iron Oxide
56375803	Chalk	56375805	Heirloom Copper	56375777	Rust

Finial Plug

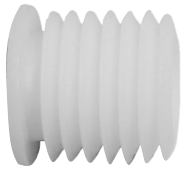

Fits		Quantity per Box	
1" Wrought Iron Poles		50 pieces per box	
Product Number & Finish			
56369058	White		

Internal Rod Splice



Fits		Quantity per Box	
1" Wrought Iron Poles		5 pieces per box	
Product Number & Finish			
56366061	Zinc Plated		

Connects two poles together for larger width options.



Petite Modern Ball | Black

1 3/8" Finials & Endcaps

Axiom

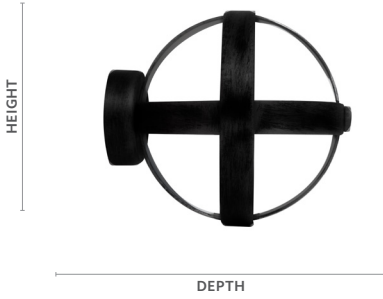

Fits	Dimensions	Quantity per Box
1 3/8" Wrought Iron Poles	Depth: 3 13/16"	5 pairs per box
1 3/8" Estate™ Traverse Rods	Height: 3 3/8"	
1 3/8" K-Rail Traverse Rods	Width: 3 3/8"	

Product Number & Finish					
56481770	Black	56481804	Graphite	56481802	Iron Oxide
56481803	Chalk	56481805	Heirloom Copper	56481777	Rust

Finial Plugs included.

Darby



Fits	Dimensions	Quantity per Box
1 3/8" Wrought Iron Poles	Depth: 3 1/4 "	5 pairs per box
1 3/8" Estate™ Traverse Rods	Height: 2"	
1 3/8" K-Rail Traverse Rods	Width: 2"	

Product Number & Finish					
56484770	Black	56484804	Graphite	56484802	Iron Oxide
56484803	Chalk	56484805	Heirloom Copper	56484777	Rust

Finial Plugs included.



Axiom | Graphite

1 3/8" Finials & Endcaps

Lincoln

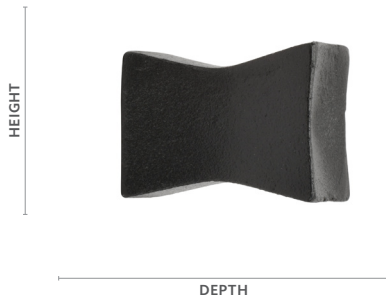

Fits	Dimensions	Quantity per Box
1 3/8" Wrought Iron Poles 1 3/8" Estate™ Traverse Rods 1 3/8" K-Rail Traverse Rods	Depth: 2 3/8" Height: 2 1/8" Width: 2 1/8"	5 pairs per box

Product Number & Finish					
56483770	Black	56483804	Graphite	56483802	Iron Oxide
56483803	Chalk	56483805	Heirloom Copper	56483777	Rust

Finial Plugs included.

Otto



Fits	Dimensions	Quantity per Box
1 3/8" Wrought Iron Poles 1 3/8" Estate™ Traverse Rods 1 3/8" K-Rail Traverse Rods	Depth: 2 1/16" Height: 3 1/4" Width: 3 1/4"	5 pairs per box

Product Number & Finish					
56482770	Black	56482804	Graphite	56482802	Iron Oxide
56482803	Chalk	56482805	Heirloom Copper	56482777	Rust

Finial Plugs included.

Pedestal Ball



Fits	Dimensions	Quantity per Box
1 3/8" Wrought Iron Poles 1 3/8" Estate™ Traverse Rods 1 3/8" K-Rail Traverse Rods	Depth: 4 7/8" Height: 3 3/8" Width: 3 3/8"	5 pairs per box

Product Number & Finish					
56451770	Black	56451804	Graphite	56451802	Iron Oxide
56451803	Chalk	56451805	Heirloom Copper	56451777	Rust

Finial Plugs included.

Petite Faucet



Fits	Dimensions	Quantity per Box
1 3/8" Wrought Iron Poles 1 3/8" Estate™ Traverse Rods 1 3/8" K-Rail Traverse Rods	Depth: 2 3/8" Height: 2 3/16" Width: 2 3/16"	5 pairs per box

Product Number & Finish					
56474770	Black	56474804	Graphite	56474802	Iron Oxide
56474803	Chalk	56474805	Heirloom Copper	56474777	Rust

Finial Plugs included.

1 3/8" Finials & Endcaps

Petite Modern Ball



Fits	Dimensions	Quantity per Box
1 3/8" Wrought Iron Poles	Depth: 3 3/8"	5 pairs per box
1 3/8" Estate™ Traverse Rods	Height: 1 15/16"	
1 3/8" K-Rail Traverse Rods	Width: 1 15/16"	

Product Number & Finish					
56473770	Black	56473804	Graphite	56473802	Iron Oxide
56473803	Chalk	56473805	Heirloom Copper	56473777	Rust

Finial Plugs included.

Ponce



Fits	Dimensions	Quantity per Box
1 3/8" Wrought Iron Poles	Depth: 5 1/2"	5 pairs per box
1 3/8" Estate™ Traverse Rods	Height: 1 1/4"	
1 3/8" K-Rail Traverse Rods	Width: 1 1/4"	

Product Number & Finish					
56485770	Black	56485804	Graphite	56485802	Iron Oxide
56485803	Chalk	56485805	Heirloom Copper	56485777	Rust

Finial Plugs included.

Endcap



Fits	Dimensions	Quantity per Box
1 3/8" Wrought Iron Poles	Depth: 1 1/8"	5 pairs per box
1 3/8" Estate™ Traverse Rods	Height: 2 1/2"	
1 3/8" K-Rail Traverse Rods	Width: 2 1/2"	

Product Number & Finish					
56458770	Black	56458804	Graphite	56458802	Iron Oxide
56458803	Chalk	56458805	Heirloom Copper	56458777	Rust

Finial Plugs included.

1 3/8" Poles

6' Pole



Diameter	Length	Quantity per Box
1 3/8"	6'	6 pieces per box

Product Number & Finish

56459770	Black	56459804	Graphite	56459802	Iron Oxide
56459803	Chalk	56459805	Heirloom Copper	56459777	Rust

8' Pole



Diameter	Dimensions	Quantity per Box
1 3/8"	8'	6 pieces per box

Product Number & Finish

56460770	Black	56460804	Graphite	56460802	Iron Oxide
56460803	Chalk	56460805	Heirloom Copper	56460777	Rust



1 3/8" Estate™ Traverse Rod

To learn more about the technical specs on Estate Traverse Rods and AMP™ Motorization, see pages 28-29.

Assembled Set with Slides



Manual Traversing Rods with Selected Carriers

Unit of Measure

Foot

AMP™ Motorization Upcharge

Charger, item #62201300 included. Remotes sold separately.

Product Number & Finish

83697770	Black	83697804	Graphite	83697802	Iron Oxide
83697803	Chalk	83697805	Heirloom Copper	83697777	Rust

Assembled Set with Wheeled Ripplefold™ Carriers



Manual Traversing Rods with Selected Carriers

Unit of Measure

Foot

AMP™ Motorization Upcharge

Charger, item #62201300 included. Remotes sold separately.

Product Number & Finish

83698770	Black	83698804	Graphite	83698802	Iron Oxide
83698803	Chalk	83698805	Heirloom Copper	83698777	Rust

1 3/8" Estate™ Keystone

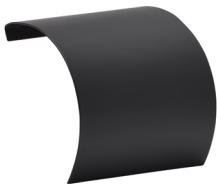

Fits

Quantity per Box

1 3/8" Estate™ Traverse Rods 25 pieces per box

Product Number & Finish

1833770	Black	1833804	Graphite	1833802	Iron Oxide
1833803	Chalk	1833805	Heirloom Copper	1833777	Rust

Double Bracket

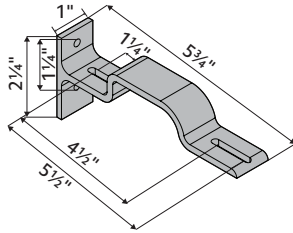

Fits	Dimensions	Quantity per Box
1 3/8" Estate™ Traverse Rods 2" Estate™ Traverse Rods	Depth: 5 3/4" Height: 2 1/4" Width: 1"	10 pieces per box
Product Number & Finish		
71134110 Satin Brass		



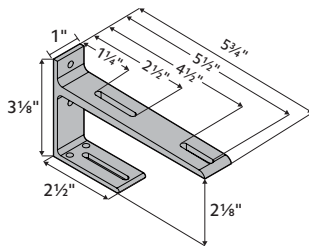





Double Bracket



Fits	Dimensions	Quantity per Box
1 3/8" Estate™ Traverse Rods 2" Estate™ Traverse Rods	Depth: 5 3/4" Height: 3 1/8" Width: 1"	10 pieces per box
Product Number & Finish		
71132062 Antique Brass	71132110 Satin Brass	
71132006 Black	71132012 Satin Nickel	

1 3/8" Estate™ Traverse Rod Components

To learn more about the technical specs on Estate Traverse Rods and AMP™ Motorization, see pages 28-29.

Item	Product No. & Finish	Description	Quantity Per Box
	62101000 White 62101010 Black	AMP Remote Control RF 2W 15 Channel	1 piece per box
	62201300 White	AMP Battery Charger 16.5V/0.89A	1 piece per box
	62102000 White	AMP Gateway USB Bridge	1 piece per box
	62109000 White	AMP Wall Switch Surface RF 2W 15 Channel	1 piece per box
	62108000 White	AMP Wall Switch RF 2W 15 Channel	1 piece per box
	2989899000	15" Cable Assembly	10 pieces per box
	1026661	4' Cable Assembly	10 pieces per box
	2989901000	10' Cable Assembly	10 pieces per box
	2989902000	20' Cable Assembly	10 pieces per box

1 3/8" Rings

Ring



Fits		Dimensions		Quantity per Box	
1 3/8" Wrought Iron Poles		Internal: 2" External: 2 1/2" External to eyelet: 2 13/16"		10 bags per box	
Product Number & Finish					
56461770	Black	56461804	Graphite	56461802	Iron Oxide
56461803	Chalk	56461805	Heirloom Copper	56461777	Rust

Bypass C-Ring



Fits		Dimensions		Quantity per Box	
1 3/8" Wrought Iron Poles		Internal: 2" External: 2 1/2" External to eyelet: 2 13/16"		10 bags per box	
Product Number & Finish					
56471770	Black	56471804	Graphite	56471802	Iron Oxide
56471803	Chalk	56471805	Heirloom Copper	56471777	Rust

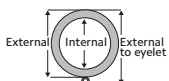

1 3/8" Brackets

3 1/2" Return Bracket



Fits	Dimensions	Quantity per Box
1 3/8" Wrought Iron Poles	Depth: 4 1/2" Height: 4 1/8" Width: 1 1/6"	Wall to Pole: 1 3/4" Return: 3 1/2" 5 pieces per box

Product Number & Finish					
56462770	Black	56462804	Graphite	56462802	Iron Oxide
56462803	Chalk	56462805	Heirloom Copper	56462777	Rust

5 3/8" Return Bracket



Fits	Dimensions	Quantity per Box
1 3/8" Wrought Iron Poles	Depth: 6 1/2" Height: 4 5/16" Width: 1 1/6"	Wall to Pole: 4 3/8" Return: 5 3/8" 5 pieces per box

Product Number & Finish					
56463770	Black	56463804	Graphite	56463802	Iron Oxide
56463803	Chalk	56463805	Heirloom Copper	56463777	Rust

3 5/8" Center Bypass Bracket



Fits	Dimensions	Quantity per Box
1 3/8" Wrought Iron Poles	Depth: 4 3/8" Height: 4 1/8" Width: 1 1/6"	Wall to Pole: 2 5/8" Return: 3 1/2" 5 pieces per box

Product Number & Finish					
56472770	Black	56472804	Graphite	56472802	Iron Oxide
56472803	Chalk	56472805	Heirloom Copper	56472777	Rust

Double Bracket



Fits	Dimensions	Quantity per Box
1 3/8" Wrought Iron Poles	Depth: 7 1/16" Height: 5 5/8" Width: 5/8"	Wall to Pole: 1 3/16" Inner Return: 3 1/2" Outer Return: 6 1/2" 5 pieces per box

Product Number & Finish					
56465770	Black	56465804	Graphite	56465802	Iron Oxide
56465803	Chalk	56465805	Heirloom Copper	56465777	Rust



Use the measurement guide to the left to help determine the correct dimensions for your selected product.

1 3/8" Bracket, Accessories & Components

Inside Mount Socket



Fits	Dimensions	Quantity per Box
1 3/8" Wrought Iron Poles	Depth: 1 1/16" Height: 2 3/8" Width: 2 3/8"	5 pairs per box

Product Number & Finish					
56470770	Black	56470804	Graphite	56470802	Iron Oxide
56470803	Chalk	56470805	Heirloom Copper	56470777	Rust

Mounts a 1" rod between two facing walls.

Swivel Socket



Fits	Dimensions	Quantity per Box
1 3/8" Wrought Iron Poles		5 pieces per box

Product Number & Finish					
56467770	Black	56467804	Graphite	56467802	Iron Oxide
56467803	Chalk	56467805	Heirloom Copper	56467777	Rust

36" Baton with Bypass C-Ring



Fits	Dimensions	Quantity per Box
1 3/8" Wrought Iron Poles	36" long	6 pieces per box

Product Number & Finish					
56376770	Black	56376804	Graphite	56376802	Iron Oxide
56376803	Chalk	56376805	Heirloom Copper	56376777	Rust

Finial Plug

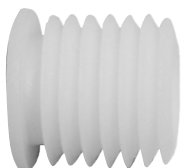

Fits	Quantity per Box
1 3/8" Wrought Iron Poles	50 pieces per box

Product Number & Finish	
56469058	White

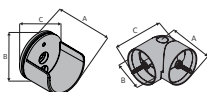

1" & 1 3/8" Accessories & Components

Internal Rod Splice



Fits	Quantity per Box
------	------------------

1 3/8" Wrought Iron Poles	5 pieces per box
---------------------------	------------------

Product Number & Finish

56466061 Zinc Plated

Connects two poles together for larger width options.

Teflon Tape

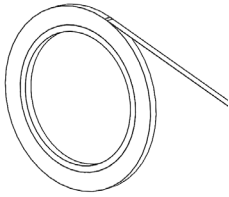

Dimensions	Quantity per Box
------------	------------------

54' per roll	1 roll per box
--------------	----------------

Product Number & Finish

84990000 Clear

Teflon tape is used on stationary poles to help rings slide smoothly across the pole.

AMP™ Motorization

Why AMP™?

The slim design of the quiet, yet powerful motor and the position on the track allows the motor to tuck seamlessly behind your drapery panel so you'll never have to sacrifice your style or comfort. For safety measures, you're able to move the draperies with a gentle tug, allowing for operation when a remote is not present or if a guest is unaware of the motorization feature. The dual battery and AC power sources allows operation in case of a power outage so draperies may be opened in the event of an emergency. AMP™ Motorization is available on our most popular traversing tracks, Estate and Architrac® Series 94001 and in drapery header styles Ripplefold™ and pleated for a variety of styling options. This is comfortable living at its finest.

For AMP™ Motorization brochure, programming instructions and installation instructions, please visit the drapery hardware resource library at kirsch.com.

Benefits & Features

AMP™ Motorization

- Motor mounts to the back of the track which allows a seamless look between motorized and manual traverse rods
- Drapery fabrication does not need to change between manually controlled draperies and motorized draperies; No additional returns or any special instructions
- Limits are set automatically after installation
- Remote control is radio frequency and easily pairs with the motor
- Tug feature; when drapery is pulled the motor will traverse the drapery
- AMP™ App with AMP™ USB Bridge
- Architrac® Series 94001 Rods with AMP™ cannot be bent or curved

Frequently Asked Questions

What is the weight capacity?

64 lbs Motor is rated to 64 lbs. Be sure not to exceed the Estate or Architrac track specifications to ensure your motor operates optimally.

Can you double the weight capacity by using two motors?

No Only use one motor per rod.

Does AMP™ offer limit setting?

Yes The motor automatically sets its limits.

Does AMP™ offer touch control?

Yes The tug feature allows you to pull on the drapery and the motor will automatically open or close your draperies.

How long is the power cord?

6 ft The durable, non-extendable power cord is extra long for out of reach places. Any extra can be rolled and secured for a tidy look. Cable extensions are available in 15", 4', 10' and 20' lengths to reach outlets that are farther away from the motor.

Is there a wall switch?

Yes There are Flush Mount and Surface Mount Wall Switches available.

Does AMP™ offer a warranty?

Yes See the Kirsch Warranty document for more information.

Download the AMP™ APP to get started



AMP™ Motorization Overview

Overview

- Soft start/stop & manual operation
- Tug feature: when drapery is pulled the motor will traverse the drapery
- Automatic limits on end stop
- Favorite/intermediate position
- Dry contact for external control
- RF Remote and wall switches
- Setting with buttons on motor units
- Setting with external dry contact switch
- LED Indicators
- One-Way and Two-Way Draw
- Pleated
- Ripplefold™
- AMP™ App with AMP™ USB Bridge

Available Colors

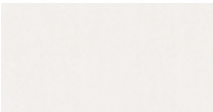

White

Side View



Front View

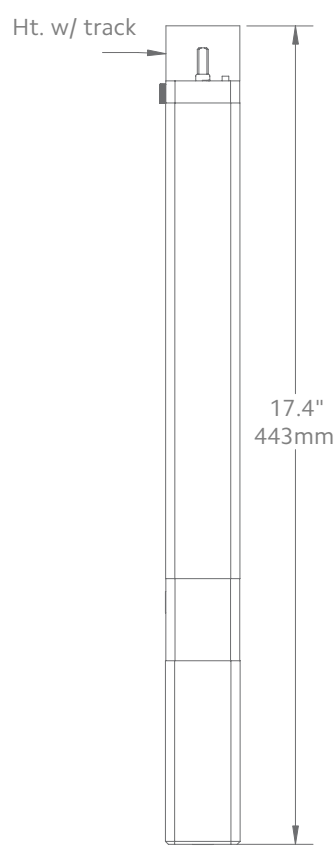

Bottom View

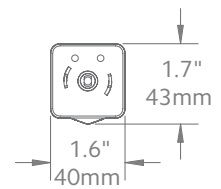

Motor Unit	Product No.
AMP™ Drapery Motor	62001300

Technical Specs	AMP™ Motor
Power Supply	DC 16.5V-0.89A (100-240VAC 50/60Hz 0.5A)
Amperage	2.55Ah
Average Linear Speed	7.8inches/sec
Power Consumption	40 watts
Torque	1.2Nm
Power Cable Length	6 feet
Variable Speed	80, 100 & 120 rpm
Certifications	UL/CE
Max. Track Length	Estate™ - 16 ft Architrac™ 94001 - 16 ft
Max. Load	64 lbs

Follow track specifications for drapery weight.



Estate™ Overview

To help determine which system is right for your project, use the guideline below to select the best fit. For more detailed information about each track, please visit our resource library at kirsch.com.

Estate™ Series	Buckingham®	Designer Metals™	Wood Trends™	Wrought Iron	Varia	Chroma
What is your preferred size?						
1 3/8"	•	•	•	•		
2"	•	•	•		•	•
What is your preferred Draw type?						
Motorized	•	•	•	•	•	•
Manual	•	•	•	•	•	•
What is your preferred Drapery Heading type?						
Pleated	•	•	•	•	•	•
Ripplefold™	•	•	•	•	•	•
What is your mounting location?						
Ceiling Mount*	•	•	•	•	•	•
Wall Mount	•	•	•	•	•	•
What is your preferred look?						
With rings		•				
Without rings	•	•	•	•	•	•

*Finial choices may be limited for ceiling mounted Estate™ Rods.

Track Performance Data

Style	Heading Style	Mount	Draw	Minimum Track Length	Maximum Track Length	Minimum Fabric Weight	Lbs. per Ft.
 83611 1 3/8" Estate™ Manual or Motorized Draw	Pleated, Ripplefold™	Ceiling, Wall	One-Way	18 in	16 ft	64 lbs	4
			Two-Way	18 in	16 ft	64 lbs	4
 93601 2" Estate™ Manual or Motorized Draw	Pleated, Ripplefold™	Ceiling, Wall	One-Way	18 in	16 ft	64 lbs	4
			Two-Way	18 in	16 ft	64 lbs	4

*Maximum track lengths and maximum fabric weight do not apply to curved track. Check with customer service for feasibility. Send complete specifications and fabric weight.

Splices & Keystones per Track

Track Length	Number of Splices	Keystones Included
8 ft. to 16 ft.	1	1

Operating Systems

Motorized Draw

AMP™ Motorization

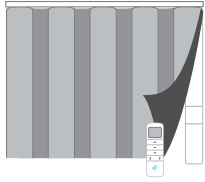

- Easy to use
- Quiet, powerful motor
- Pleated or Ripplefold™
- For Estate™ Traverse Rods or Architrac® Series 94001
- For more information, see page 46

Manual Draw

Cord Draw

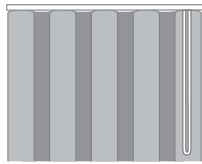

- Easy to use
- Pleated or Ripplefold™

Hand/Baton Draw



- Easy to use
- A gentle tug allows drapery to glide across track
- Pleated or Ripplefold™

Baton Duplex Draw

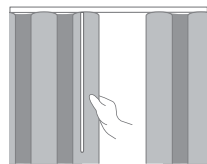

- Easy to use
- Used on split draw rods
- Pleated or Ripplefold™
- When the baton is pulled on one stack, draperies on both sides of the traverse rod open or close.

Header Styles

Ripplefold™

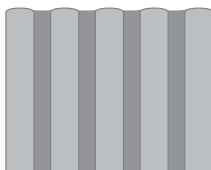

- Panels can be pressed flat, yet fall into fold
- No hooks or pins
- Headings are suspended under track
- Stack back is less than conventional pleated draperies
- Draperies snap on/off carriers for easy installation
- Interior drapery appearance is identical to exterior-facing appearance

Pleated

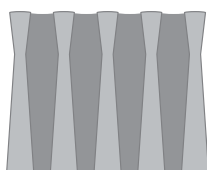

- A classic header option
- Can be used with most track systems using slip-in or pin-on hooks
- Headings can be suspended under the track or over the face of the track to conceal hardware
- Four carries per foot is standard, additional carriers or rings can be ordered.





Bracket Spacing & Mount Options

Place bracket at each end, place next bracket a maximum of 24" from first, then place remaining brackets at 48" intervals over the remainder of the track. Spacing may need to be shortened for heavier draperies. All mounting options are compatible with our AMP™ Motorization.



Wall Mount using parts:

To achieve this look, order Estate rod, wall mount and all components will be included.

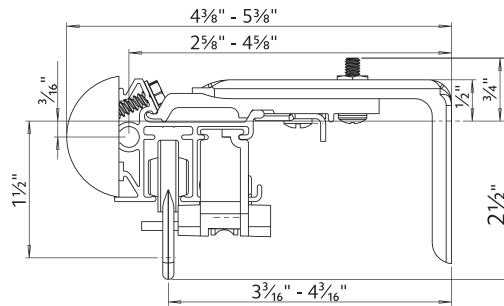

94129061 Zinc	1856973 Satin Nickel	1856978 Brushed Bronze	1857324 Black
	or 	or 	or 

1 3/8" Wall Mount



Ceiling Mount using parts:

To achieve this look, order Estate rod, ceiling mounted. 94130xxx brackets are included with the rod. Then order item 1796061 ceiling mount bracket in the quantity needed based on the bracket spacing drawing on page 34.

94130xxx	1796061
	or 

1 3/8" Ceiling Mount

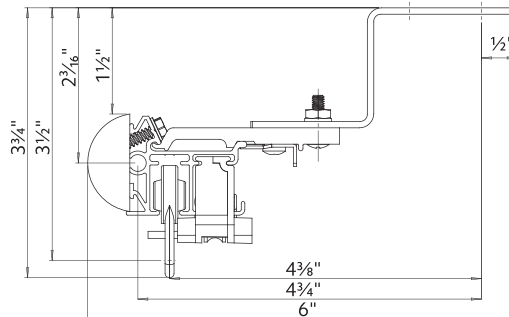

Double Wall Mount using parts:

To achieve this look, order Estate rod, ceiling mounted. 94130xxx brackets are included with the rod. Then order one, item 94125xxx double bracket and two, item 1796061 ceiling mount brackets multiplied by the quantity needed based on the bracket spacing drawing on page 34.

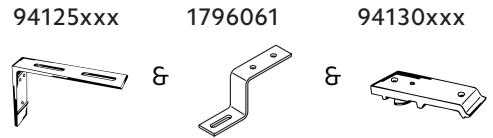

1 3/8" Double Wall Mount

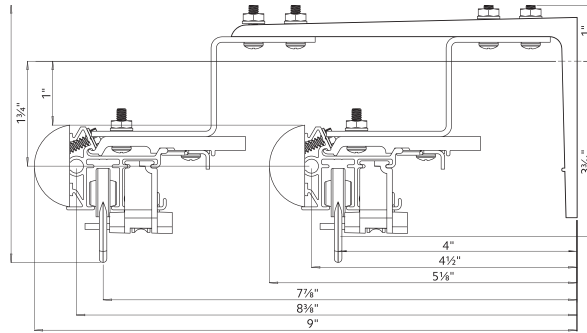

Double Staggered Wall Mount using parts:

To achieve this look, order Estate rod ceiling mounted. 94130xxx brackets are included with the rod. Then order one, item 71132xxx double bracket in the quantity needed based on the bracket spacing drawing on page 34.

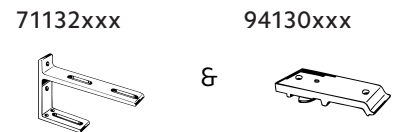

1 3/8" Double Staggered Wall Mount

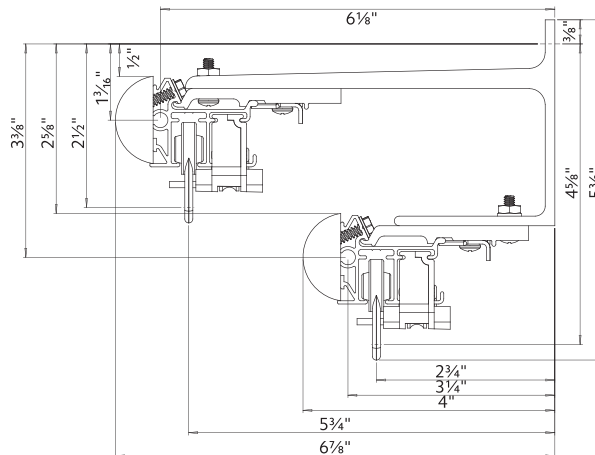

Double Wall Mount using parts:

To achieve this look, order Estate rod ceiling mounted. 94130xxx brackets are included with the rod. Then order one, item 71134110 double bracket in the quantity needed based on the bracket spacing drawing on page 34.

71134110

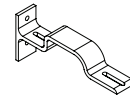

94130xxx

&



1 3/8" Front & 1 3/8" Back Double Wall Mount

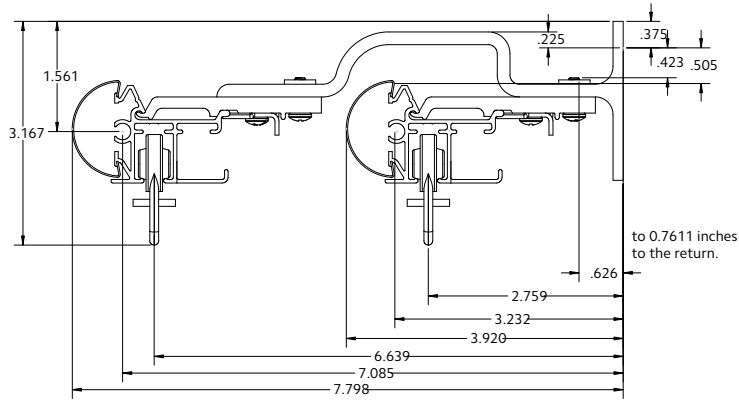

Calculating Drapery Weight

1. Fabric Weight

Some fabric samples list on the back of the swatch the weight listed in Ounces/SqYd (ounces per square yard). Call the manufacturer for the weight if not listed.

2. Lining Weight

Most drapery linings are 2oz - 4oz per square yard.

Drapery Weight Formula

Total Square Yards = (total yards x 36 x fabric width) ÷ 1296 (1-square yard)

Weight = total square yards x weight in ounces per SqYd) ÷ 16 oz in lb

Example 32 yards of 54" wide fabric weighing 14 oz/SqYd
Total square yards = (32 x 36 x 54) = 62,208 ÷ 1296 = 48 SqYds
Weight = (48 x 14oz) = 672 ÷ 16 = 42 lbs

Lining Weight Formula

Total Square Yards = (total yards x 36 x fabric width) ÷ 1296 (1-square yard)

Weight = total square yards x weight in ounces per SqYd) ÷ 16 oz in lb

Example 32 yards of 54" wide fabric weighing 6 oz/SqYd
Total square yards = (32 x 36 x 54) = 62,208 ÷ 1296 = 48 SqYds
Weight = (48 x 4oz) = 192 ÷ 16 = 12 lbs

Fabrics by Weight

Contact the fabric manufacturer for your specific fabric weight.

Fabric Type	Weight per Square Yard
Drapery Lining	2-4oz
Interlining	5-6oz
Blackout Lining	6-10oz
Bump Lining	12-14oz
Silks	2-4oz
Chintz	2-4oz
Printed Cottons	4-6oz
Linens	6-10oz
Jacquards	10-14oz
Velvets	14-18oz

Stack Guides

Pleated Stack Guide (for 16 mm carriers)

Note: Stack size is estimated. Type of fabric used could alter these measurements.

Size of Track (in inches)	5 carriers per foot 3x fullness		4 carriers per foot 2½x fullness		3 carriers per foot 2x fullness	
	Stackback One-Way	Stackback Two-Way (per side)	Stackback One-Way	Stackback Two-Way (per side)	Stackback One-Way	Stackback Two-Way (per side)
18	11.75	8.75	10.5	8.5	10.5	8.5
24	13	9.25	11.75	8.75	10.5	8.5
30	15.75	10.5	13	9.25	11.75	8.75
36	17	11.25	14.5	10	13	9.25
42	18.5	12	15.75	10.5	14.5	10
48	19.75	12.5	17	11.25	14.5	10
54	22.25	14	18.5	12	15.75	10.5
60	23.75	14.5	19.75	12.5	17	11.25
66	25	15.25	21	13.25	18.5	12
72	26.25	16	22.25	14	18.5	12
78	29	17.25	23.75	14.5	19.75	12.5
84	30.25	18	25	15.25	21	13.25
90	31.5	18.5	26.25	16	22.25	14
96	33	19.25	27.5	16.5	22.25	14
102	35.5	20.5	29	17.25	23.75	14.5
108	36.75	21.25	30.25	18	25	15.25
114	38.25	21.75	31.5	18.5	26.25	16
120	39.5	22.5	33	19.25	26.25	16
126	42.25	23.75	34.25	19.75	27.5	16.5
132	43.5	24.5	35.5	20.5	29	17.25
138	44.75	25.25	36.75	21.25	30.25	18
144	46	25.75	38.25	21.75	30.25	18
150	48.75	27	39.5	22.5	31.5	18.5
156	50	27.75	40.75	23.25	33	19.25
162	51.5	28.5	42.25	23.75	34.25	19.75
168	52.75	29	43.5	24.5	34.25	19.75
174	55.25	30.5	44.75	25.25	35.5	20.5
180	56.75	31	46	25.75	36.75	21.25
186	58	31.75	47.5	26.5	38.25	21.75
192	59.25	32.5	48.75	27	38.25	21.75
198	62	33.75	50	27.75	39.5	22.5
204	63.25	34.5	51.5	28.5	40.75	23.25
210	64.5	35	52.75	29	42.25	23.75
216	66	35.75	54	29.75	42.25	23.75
222	68.5	37	55.25	30.5	43.5	24.5
228	69.75	37.75	56.75	31	44.75	25.25
234	71.25	38.25	58	31.75	46	25.75
240	72.5	39	59.25	32.5	46	25.75

Ripplefold™ Butt Master Stack Guide

Note: Stack size is estimated. Type of fabric used could alter these measurements. Please refer to the Ripplefold Fabrication Manual for more information.

120% FULLNESS	100% FULLNESS	80% FULLNESS	60% FULLNESS	NUMBER OF FACTORY SNAPS	SNAP TAPE LENGTH (LESS RETURN LENGTH)*	PANEL STACKBACK
15.00	17.00	19.00	21.00	8	32.50	8.75
18.75	21.25	23.75	26.25	10	41.00	10.00
22.50	25.50	28.50	31.50	12	49.50	11.00
26.25	29.75	33.25	36.75	14	58.00	12.00
30.00	34.00	38.00	42.00	16	66.50	13.25
33.75	38.25	42.75	47.25	18	75.00	14.25
37.50	42.50	47.50	52.50	20	83.50	15.25
41.25	46.75	52.25	57.75	22	92.00	16.50
45.00	51.00	57.00	63.00	24	100.50	17.50
48.75	55.25	61.75	68.25	26	109.00	18.50
52.50	59.50	66.50	73.50	28	117.50	19.75
56.25	63.75	71.25	78.75	30	126.00	20.75
60.00	68.00	76.00	84.00	32	134.50	21.75
63.75	72.25	80.75	89.25	34	143.00	23.00
67.50	76.50	85.50	94.50	36	151.50	24.00
71.25	80.75	90.25	99.75	38	160.00	25.00
75.00	85.00	95.00	105.00	40	168.50	26.25
78.75	89.25	99.75	110.25	42	177.00	27.25
82.50	93.50	104.50	115.50	44	185.50	28.25
86.25	97.75	109.25	120.75	46	194.00	29.50
90.00	102.00	114.00	126.00	48	202.50	30.50
93.75	106.25	118.75	131.25	50	211.00	31.50
97.50	110.50	123.50	136.50	52	219.50	32.50
97.50	110.50	123.50	136.50	52	219.50	32.50
101.25	114.75	128.25	141.75	54	228.00	33.75
105.00	119.00	133.00	147.00	56	236.50	34.75
108.75	123.25	137.75	152.25	58	245.00	35.75
112.50	127.50	142.50	157.50	60	253.50	37.00
116.25	131.75	147.25	162.75	62	262.00	38.00
120.00	136.00	152.00	168.00	64	270.50	39.00
123.75	140.25	156.75	173.25	66	279.00	40.25
127.50	144.50	161.50	178.50	68	287.50	41.25
131.25	148.75	166.25	183.75	70	296.00	42.25
135.00	153.00	171.00	189.00	72	304.50	43.50
138.75	157.25	175.75	194.25	74	313.00	44.50
142.50	161.60	180.50	199.50	76	321.50	45.50
146.25	165.75	185.25	204.75	78	330.00	46.75
150.00	170.00	190.00	210.00	80	338.50	47.75

Ripplefold™ Butt Master Stack Guide

Note: Stack size is estimated. Type of fabric used could alter these measurements. Please refer to the Ripplefold Fabrication Manual for more information.

120% FULLNESS	100% FULLNESS	80% FULLNESS	60% FULLNESS	NUMBER OF FACTORY SNAPS	SNAP TAPE LENGTH (LESS RETURN LENGTH)*	PANEL STACKBACK
153.75	174.25	194.75	215.25	82	347.00	48.75
157.50	178.50	199.50	220.50	84	355.50	50.00
161.25	182.75	204.25	225.75	86	364.00	51.00
165.00	187.00	209.00	231.00	88	372.50	52.00
168.75	191.25	213.75	236.25	90	381.00	53.25
172.50	195.50	218.50	241.50	92	389.50	54.25
176.25	199.75	223.25	246.75	94	398.00	55.25
180.00	204.00	228.00	252.00	96	406.50	56.25
183.75	208.25	232.75	257.25	98	415.00	57.50
187.50	212.50	237.50	262.50	100	423.50	58.50
191.25	216.75	242.25	267.75	102	432.00	59.50
195.00	221.00	247.00	273.00	104	440.50	60.75
198.75	225.25	251.75	278.25	106	449.00	61.75
202.50	229.50	256.50	283.50	108	457.50	62.75
206.25	233.75	261.25	288.75	110	466.00	64.00
210.00	238.00	266.00	294.00	112	474.50	65.00
213.75	242.25	270.75	299.25	114	483.00	66.00
217.50	246.50	275.50	304.50	116	491.50	67.25
221.25	250.75	280.25	309.75	118	500.00	68.25
225.00	255.00	285.00	315.00	120	508.50	69.25
228.75	259.25	289.75	320.25	122	517.00	70.50
232.50	263.50	294.50	325.50	124	525.50	71.50
236.25	267.75	299.25	330.75	126	534.00	72.50
240.00	272.00	304.00	336.00	128	542.50	73.75
243.75	276.25	308.75	341.25	130	551.00	74.75
247.50	280.50	313.50	346.50	132	559.50	75.75
251.25	284.75	318.25	351.75	134	568.00	77.00
255.00	289.00	323.00	357.00	136	576.50	78.00
258.75	293.25	327.75	362.25	138	585.00	79.00
262.50	297.50	332.50	367.50	140	593.50	80.00
266.25	301.75	337.25	372.75	142	602.00	81.25
270.00	306.00	342.00	378.00	144	610.50	82.25
273.75	310.25	346.75	383.25	146	619.00	83.25
277.50	314.50	351.50	388.50	148	627.50	84.50
281.25	318.75	356.25	393.75	150	636.00	85.50

Ripplefold™ Overlap Stack Guide

Note: Stack size is estimated. Type of fabric used could alter these measurements. Please refer to the Ripplefold Fabrication Manual for more information.

120% FULLNESS	100% FULLNESS	80% FULLNESS	60% FULLNESS	NUMBER OF FACTORY SNAPS	SNAP TAPE LENGTH (LESS RETURN LENGTH)*	PANEL STACKBACK
15.00	17.00	19.00	21.00	8	34.00	10.75
18.75	21.25	23.75	26.25	10	42.50	12.00
22.50	25.50	28.50	31.50	12	51.00	13.00
26.25	29.75	33.25	36.75	14	59.50	14.00
30.00	34.00	38.00	42.00	16	68.00	15.25
33.75	38.25	42.75	47.25	18	76.50	16.25
37.50	42.50	47.50	52.50	20	85.00	17.25
41.25	46.75	52.25	57.75	22	93.50	18.50
45.00	51.00	57.00	63.00	24	102.00	19.50
48.75	55.25	61.75	68.25	26	110.50	20.50
52.50	59.50	66.50	73.50	28	119.00	21.75
56.25	63.75	71.25	78.75	30	127.50	22.75
60.00	68.00	76.00	84.00	32	136.00	23.75
63.75	72.25	80.75	89.25	34	144.50	25.00
67.50	76.50	85.50	94.50	36	153.00	26.00
71.25	80.75	90.25	99.75	38	161.50	27.00
75.00	85.00	95.00	105.00	40	170.00	28.25
78.75	89.25	99.75	110.25	42	178.50	29.25
82.50	93.50	104.50	115.50	44	187.00	30.25
86.25	97.75	109.25	120.75	46	195.50	31.50
90.00	102.00	114.00	126.00	48	204.00	32.50
93.75	106.25	118.75	131.25	50	212.50	33.50
97.50	110.50	123.50	136.50	52	221.00	34.50
101.25	114.75	128.25	141.75	54	229.50	35.75
105.00	119.00	133.00	147.00	56	238.00	36.75
108.75	123.25	137.75	152.25	58	246.50	37.75
112.50	127.50	142.50	157.50	60	255.00	39.00
116.25	131.75	147.25	162.75	62	263.50	40.00
120.00	136.00	152.00	168.00	64	272.00	41.00
123.75	140.25	156.75	173.25	66	280.50	42.25
127.50	144.50	161.50	178.50	68	289.00	43.25
131.25	148.75	166.25	183.75	70	297.50	44.25
135.00	153.00	171.00	189.00	72	306.00	45.50
138.75	157.25	175.75	194.25	74	314.50	46.50
142.50	161.50	180.50	199.50	76	323.00	47.50
146.25	165.75	185.25	204.75	78	331.50	48.75
150.00	170.00	190.00	210.00	80	340.00	49.75
153.75	174.25	194.75	215.25	82	348.50	50.75

Ripplefold™ Overlap Stack Guide

Note: Stack size is estimated. Type of fabric used could alter these measurements. Please refer to the Ripplefold Fabrication Manual for more information.

120% FULLNESS	100% FULLNESS	80% FULLNESS	60% FULLNESS	NUMBER OF FACTORY SNAPS	SNAP TAPE LENGTH (LESS RETURN LENGTH)*	PANEL STACKBACK
150.00	170.00	190.00	210.00	80	340.00	49.75
153.75	174.25	194.75	215.25	82	348.50	50.75
157.50	178.50	199.50	220.50	84	357.00	52.00
161.25	182.75	204.25	225.75	86	365.50	53.00
165.00	187.00	209.00	231.00	88	374.00	54.00
168.75	191.25	213.75	236.25	90	382.50	55.25
172.50	195.50	218.50	241.50	92	391.00	56.25
176.25	199.75	223.25	246.75	94	399.50	57.25
180.00	204.00	228.00	252.00	96	408.00	58.25
183.75	208.25	232.75	257.25	98	416.50	59.50
187.50	212.50	237.50	262.50	100	425.00	60.50
191.25	216.75	242.25	267.75	102	433.50	61.50
195.00	221.00	247.00	273.00	104	442.00	62.75
198.75	225.25	251.75	278.25	106	450.50	63.75
202.50	229.50	256.50	283.50	108	459.00	64.75
206.25	233.75	261.25	288.75	110	467.50	66.00
210.00	238.00	266.00	294.00	112	476.00	67.00
213.75	242.25	270.75	299.25	114	484.50	68.00
217.50	246.50	275.50	304.50	116	493.00	69.25
221.25	250.75	280.25	309.75	118	501.50	70.25
225.00	255.00	285.00	315.00	120	510.00	71.25
228.75	259.25	289.75	320.25	122	518.50	72.50
232.50	263.50	294.50	325.50	124	527.00	73.50
236.25	267.75	299.25	330.75	126	535.50	74.50
240.00	272.00	304.00	336.00	128	544.00	75.75
243.75	276.25	308.75	341.25	130	552.50	76.75
247.50	280.50	313.50	346.50	132	561.00	77.75
251.25	284.75	318.25	351.75	134	569.50	79.00
255.00	289.00	323.00	357.00	136	578.00	80.00
258.75	293.25	327.75	362.25	138	586.50	81.00
262.50	297.50	332.50	367.50	140	595.00	82.00
266.25	301.75	337.25	372.75	142	603.50	83.25
270.00	306.00	342.00	378.00	144	612.00	84.25
273.75	310.25	346.75	383.25	146	620.50	85.25
277.50	314.50	351.50	388.50	148	629.00	86.50
281.25	318.75	356.25	393.75	150	637.50	87.50

Pole Installation, Cutting & Splicing

Top Hole Installation Guide

This chart will position the bracket so the drapery will clear the floor approximately ½".

1. Find your pole style, size and header style in the chart.
2. Determine the desired finished drapery length.
3. Add or subtract number in the top hole column from the drapery's finished length to determine how high to measure for the top hole of the bracket.

Stationary Poles					
	Rod Pocket (no top ruffle)			Pleated (any variety)	
	Top Hole			Top Hole	Pin Set
1" Standard Bracket	+¾"			+2⅝"	¼"

Wall Mount Traverse Rods					
	Pleated (any variety)			Ripplefold™ (any fullness)	
	Top Hole for Wall Mount	Floor to Ceiling Deduction	Suggested Pin Set	Top Hole for Wall Mount	Floor to Ceiling Deduction
1⅜" Estate™	+1⅛"	-2⅛"	½"	+1⅛"	-2⅛"

Ceiling Mount Traverse Rods					
1⅜" Estate™	+0"	-3⅝"	½"	+0"	-3⅝"

Cutting & Splicing Wrought Iron Poles

- Measure to desired length and carefully wrap area with an easy peel, blue painter's tape as not to damage the finish.
- Cut through the tape with sharp fine tooth saw or a pipe cutter with a stainless steel blade. Cut slowly to reduce any chipping to the product finish.
- For spliced poles, add a finial plug to the end cut.
- Splice fits inside the pole and is specific to the pole diameter.



Finial Plug
Part #56369058
or #56469058



Splice
Part #56366061
or #56466061

PRODUCT NO.	PAGE	PRODUCT NO.	PAGE	PRODUCT NO.	PAGE	PRODUCT NO.	PAGE
1026661	25	56374802	11	56376804	28	56460803	23
1833770	22	56375770	17	56376805	28	56460804	23
1833777	22	56375777	17	56381770	8	56460805	23
1833802	22	56375802	17	56381777	8	56461770	26
1833803	22	56351803	11	56381802	8	56461777	26
1833804	22	56351804	11	56381803	8	56461802	26
1833805	22	56351805	11	56381804	8	56461803	26
2989899000	25	56358803	12	56381805	8	56461804	26
2989901000	25	56358804	12	56382770	8	56461805	26
2989902000	25	56358805	12	56382777	8	56462770	27
56351770	11	56359803	13	56382802	8	56462777	27
56351777	11	56359804	13	56382803	8	56462802	27
56351802	11	56359805	13	56382804	8	56462803	27
56358770	12	56360803	13	56382805	8	56462804	27
56358777	12	56360804	13	56383770	8	56462805	27
56358802	12	56360805	13	56383777	8	56463770	27
56359770	13	56361803	14	56383802	8	56463777	27
56359777	13	56361804	14	56383803	8	56463802	27
56359802	13	56361805	14	56383804	8	56463803	27
56360770	13	56362803	15	56383805	8	56463804	27
56360777	13	56362804	15	56384770	8	56463805	27
56360802	13	56362805	15	56384777	8	56465770	27
56361770	14	56363803	15	56384802	8	56465777	27
56361777	14	56363804	15	56384803	8	56465802	27
56361802	14	56363805	15	56384804	8	56465803	27
56362770	15	56365803	15	56384805	8	56465804	27
56362777	15	56365804	15	56385770	11	56465805	27
56362802	15	56365805	15	56385777	11	56466061	28
56363770	15	56367803	16	56385802	11	56467770	28
56363777	15	56367804	16	56385803	11	56467777	28
56363802	15	56367805	16	56385804	11	56467802	28
56365770	15	56370803	16	56385805	11	56467803	28
56365777	15	56370804	16	56451770	20	56467804	28
56365802	15	56370805	16	56451777	20	56467805	28
56366061	17	56371803	14	56451802	20	56469058	28
56367770	16	56371804	14	56451803	20	56470770	28
56367777	16	56371805	14	56451804	20	56470777	28
56367802	16	56372803	15	56451805	20	56470802	28
56369058	17	56372804	15	56458770	22	56470803	28
56370770	16	56372805	15	56458777	22	56470804	28
56370777	16	56373803	11	56458802	22	56470805	28
56370802	16	56373804	11	56458803	22	56471770	26
56371770	14	56373805	11	56458804	22	56471777	26
56371777	14	56374803	11	56458805	22	56471802	26
56371802	14	56374804	11	56459770	23	56471803	26
56372770	15	56374805	11	56459777	23	56471804	26
56372777	15	56375803	17	56459802	23	56471805	26
56372802	15	56375804	17	56459803	23	56472770	27
56373770	11	56375805	17	56459804	23	56472777	27
56373777	11	56376770	28	56459805	23	56472802	27
56373802	11	56376777	28	56460770	23	56472803	27
56374770	11	56376802	28	56460777	23	56472804	27
56374777	11	56376803	28	56460802	23	56472805	27

PRODUCT NO.	PAGE	PRODUCT NO.	PAGE
56473770	20	83697770	24
56473777	20	83697777	24
56473802	20	83697802	24
56473803	20	83697803	24
56473804	20	83697804	24
56473805	20	83697805	24
56474770	20	83698770	24
56474777	20	83698777	24
56474802	20	83698802	24
56474803	20	83698803	24
56474804	20	83698804	24
56474805	20	83698805	24
56481770	19	84990000	29
56481777	19		
56481802	19		
56481803	19		
56481804	19		
56481805	19		
56482770	19		
56482777	19		
56482802	19		
56482803	19		
56482804	19		
56482805	19		
56483770	19		
56483777	19		
56483802	19		
56483803	19		
56483804	19		
56483805	19		
56484770	19		
56484777	19		
56484802	19		
56484803	19		
56484804	19		
56484805	19		
56485770	20		
56485777	20		
56485802	20		
56485803	20		
56485804	20		
56485805	20		
62102000	25		
62101010	25		
62101000	25		
62108000	25		
62109000	25		
62201300	25		
71134110	24		
71132006	24		
71132012	24		
71132062	24		
71132110	24		



Buckingham®
redefining luxury

Designer Metals™
inspiring brilliance

Wood Trends™
renewing traditions

Wrought Iron
forging artistry

**Custom Rodding
& Basic Hardware**
unique solutions