



RIPPLEFOLD® DRAPERY SYSTEM FABRICATION GUIDE

updated July 2008



RIPPLEFOLD® **DRAPERIES SYSTEM**

Uniformly Beautiful, Inside and Out

Soft, ripple-like folds flow smoothly from one end of the track to the other. The effect is gently tailored – suitable for either commercial or residential installations. Master carriers that butt together, and carriers that swivel, eliminate “flat” drapery areas.

Folds are identically beautiful from inside the room or outside the building presenting an architectural advantage. Headings, suspended under the track, cannot tip or sag. They are always perfectly positioned and spaced.

Advantages

- Minimum track exposure
- Low maintenance
- Easy, economical fabrication

How it Works

The desired style of track system is mounted on wall, ceiling or in recess. Using this fabrication guide for specifications, tape is stitched to flat, hemmed panels of fabric. Panels snap to carriers, creating a graceful, uniform flow of ripple-like folds.

Less Stackback, More Light

Ripple-like folds stack back to very ends of track – actually takes less space than conventionally pleated draperies. More glass is exposed, so more light can come in.

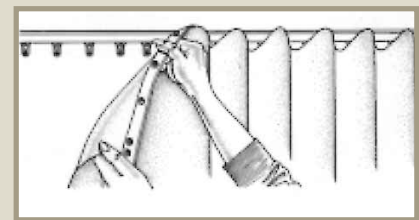
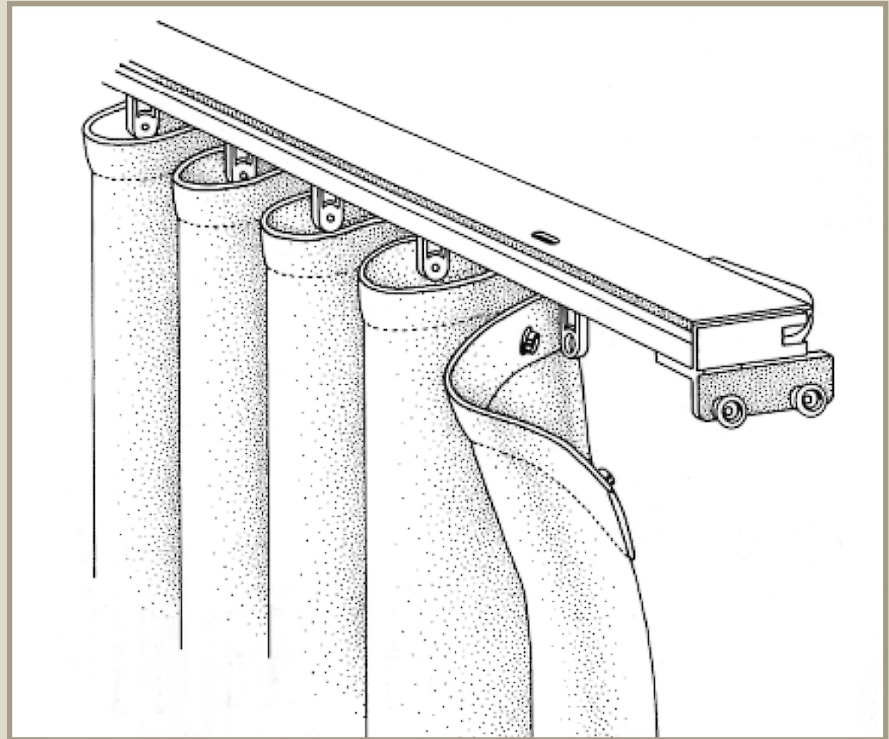

Ease and Economy of Fabrication

Forget pleat stitching! Ripplefold needs only straight hemming. Crinoline is unnecessary. The permanently stiffened nylon snap-tape supports headings through repeated laundering or cleaning. Ripplefold draperies take less fabric per panel than conventionally pleated drapery headings. Not every fabric will look correct with Ripplefold. For best appearance, the drapery fabric should be compatible with the heading system. If in doubt, a sample drapery should be made up and installed to check appearance.

Fabric requirements are also easier to figure because there is only one spacing on snap-tape. Follow the chart on page 6.

Lower Maintenance Time and Cost

The speed and ease of snapping panels into place reduces maintenance time and expense. Draperies stay lovely longer because they are handled less.

Off the track, Ripplefold draperies are perfectly flat. Laundering, cleaning and pressing are simpler, less expensive. Draperies fall into lovely, soft, natural folds when panels are snapped to carriers.

Choice of Butt-Masters or Overlap-Masters



Butt-Master



Overlap-Master

Butt-Masters*: Butt together in center for continuous looking flow in drapery folds. Also, best for one-way draws.

*Cord draw only

Overlap-Masters: Overlap in center for complete privacy.

Nylon Snap Tape

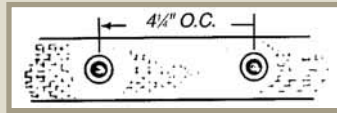

92145-1

Permanently stiffened nylon tape stitches to flat drapery panels. Pre-attached male snaps are spaced 4 1/4" on centers.

Track Systems

Ripplefold can be used on the following track systems:

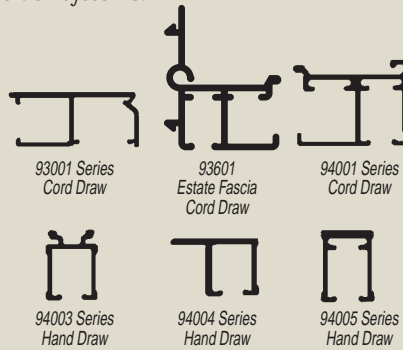

(When using overlap stiffener for Baton Draw system, use Fabrication Guide F0337018.)

Draw Systems

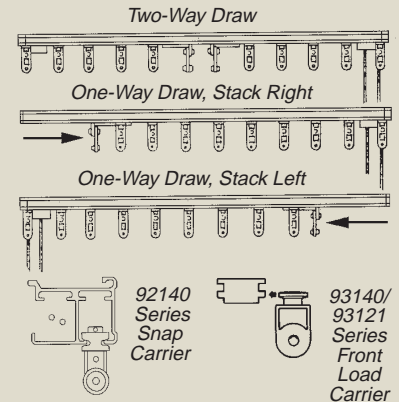

Carriers

Choose our standard snap carrier, which is smaller in diameter, producing less stack back, or use the front load carrier for easy installation and removal of draperies.

How to Order Track Set

1. Select type of track system
 2. Select type of draw system
 3. Select butt or overlap-masters*
- *Butt-master is cord draw only

Carrier Spacing Determines Drapery Fullness and Stackback Width

<p>No. 92140 No. 93140 1 1/2" spaced carriers provide 120% drapery fullness.</p>	<p>No. 92140 Stackback Width</p> <p>No. 93140 Stackback Width</p> <p>4 1/4" Stackback Depth</p>
<p>No. 92141 No. 93141 2 1/8" spaced carriers provide 100% drapery fullness.</p>	<p>No. 92141 Stackback Width</p> <p>No. 93141 Stackback Width</p> <p>4 1/4" Stackback Depth</p>
<p>No. 92142 No. 93142 2 3/8" spaced carriers provide 80% drapery fullness.</p>	<p>No. 92142 Stackback Width</p> <p>No. 93142 Stackback Width</p> <p>4 1/4" Stackback Depth</p>
<p>No. 92143 No. 93143 2 1/2" spaced carriers provide 60% drapery fullness.</p>	<p>No. 92143 Stackback Width</p> <p>No. 93143 Stackback Width</p> <p>4 1/4" Stackback Depth</p>

RIPPLEFOLD® DRAPERY FABRICATION

Example (Determining Specs)

Treatment will cover an area 120" wide. Desired fullness is 80%. Suggest a Two-Way Draw system, with snap carriers and Butt-Masters.

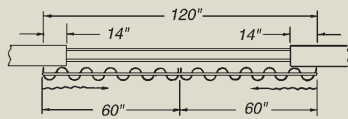

Panel Coverages

Because this will be a two-way draw track system, there will be two panels. The track length is 120", therefore the coverage area of each panel will be 60".

Using the chart on page 6, locate the column for 80% fullness. Move down the column to the 60-64" row. This row contains all required information for this particular treatment: Fabric Width (Hemmed) will be 119", Stackback (per panel, for snap carriers) will be 14". There will be 28 carriers (snaps) and 27 spaces on the snap-tape.

A. Determine Specifics of Your Treatment

- Decide the following conditions:
 - Width of area treatment will cover (width of track)
 - Desired fullness (60%, 80%, 100% or 120%)
 - One-Way or Two-Way Draw
 - Snap or Front Load Carriers
 - Butt-Masters or Overlap Masters
- Determine the coverage per panel. For a One-Way draw system you will have one panel, therefore the coverage per panel will be equal to the width of your track. For a Two-Way draw system you will have two panels, therefore the coverage per panel will be half the width of your track.
- Follow the chart on page 6. Find the column with your desired fullness, move down the column to the row with your panel coverage measurement. This row gives you the fabric width (hemmed), stackback (per panel), number of carriers and number of full spaces. NOTE: Due to slight manufacturing variations, the total length of snap tape may not exactly match the panel width. Begin with snap tape aligned correctly at master end, allow variation at return end.

B. Measure and Cut Snap-tape

- Count off the number of snaps on the tape and mark for cut-off, allowing extra tape for hems as well as for additional master carrier and return snaps (as shown on page 5).
- Follow specific instructions and diagrams for Butt-Masters, overlap-masters and returns on page 5.

NOTE: First factory snap is one of two snaps that will attach to the master carrier. A second master carrier snap must be added, as shown on next page (C). The following measurements for the Butt-Master, Overlap-Master and return allow for 1/2" hem on each end of tape.

Butt-Master: Cut-off tape 2 1/4" before the first factory snap. Make a mark 1" before the first factory snap, this is where the second master snap will be added.

Butt-Master tape cut-off and snap positions.

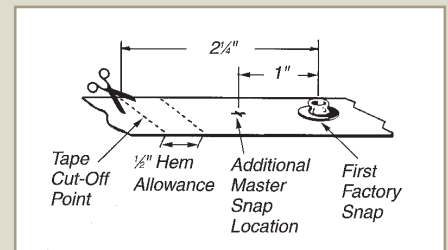

Overlap-Master: Cut-off tape $3\frac{3}{4}$ " before the first factory snap. Make a mark $2\frac{1}{2}$ " before the first factory snap. This is where the second master snap will be added.

Overlap-Master tape cut-off and snap positions.

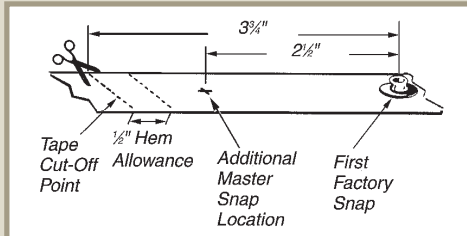

C. Add Second Master Snap

1. Pierce tape at the position you have marked.

Pierce tape at marked position.

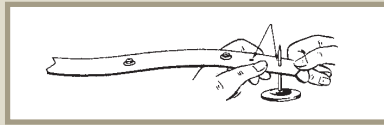

2. Insert eyelet through hole, cover with male snap, and rivet together using No. 92900 bench snap tool or hand tool No. 92901.

Return: Add $\frac{1}{2}$ " hem allowance to your desired return length. Measure this distance from last factory snap and cut tape here. Use hook to secure return to track.

Return tape cut-off and snap positions.

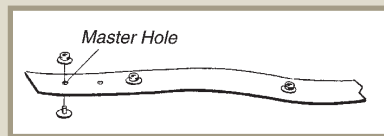
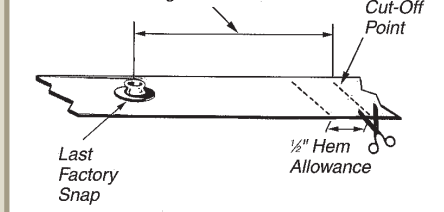

Insert eyelet, cover with male snap.

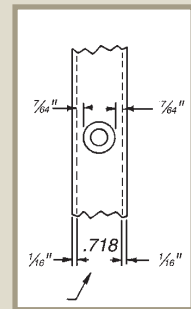

Correct Needle Spacing

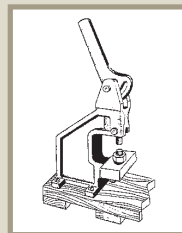

No. 92900 bench snap tool.

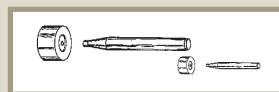

No. 92901 hand tool.

D. Prepare Panels

1. Cut and hem panels to required width and desired length.

NOTE: Allow for track clearance plus desired floor clearance. A 1" hem is sufficient for heading; stiffened nylon tape provides adequate support. For additional support for light weight fabrics, buckram can be added.

Spacing for double needle heads should be $.718$ " or $\frac{23}{32}$ ".

2. Place tape on heading of flat panel. Turn each end of tape under $\frac{1}{2}$ ". Using a zipper foot, sew heading from master end. Stitch as closely as possible to top of heading to prevent the fabric from coming into contact with track during operation.

3. Panels are now ready for attachment to track set. Beginning with master carrier simply snap panels into carriers.

Ripplefold® Fabrication Charts

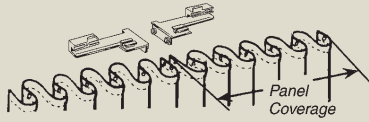

**For Butt-Master
Carriers**

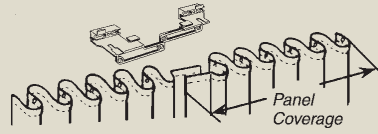

**For Overlap-
Master Carriers**

No. of Full Spaces	** Fabric Width (Hemmed)	PANEL COVERAGE				Stack Back Widths		* No. of Carriers Required
		92140 93140 120%	92141 93141 100%	92142 93142 80%	92143 93143 60%	Std. Snap Carrier	Front Load Carriers	
7	34	13-13	13-14	13-16	16-18	5½	6	8
9	42½	14-16	15-19	17-21	19-23	6¼	7	10
11	51	17-20	20-23	22-26	24-28	7¼	8¼	12
13	59½	21-24	24-27	27-30	29-34	8	9¼	14
15	68	25-28	28-31	31-35	35-39	9	10½	16
17	76½	29-31	32-36	36-40	40-44	9¾	11½	18
19	85	32-35	37-40	41-45	45-49	10¼	12¼	20
21	93½	36-39	41-44	46-49	50-55	11½	13⅝	22
23	102	40-43	45-48	50-54	56-60	12½	15	24
25	110½	44-46	49-53	55-59	61-65	13½	16⅝	26
27	119	47-50	54-57	60-64	66-70	14	17½	28
29	127½	51-54	58-61	65-68	71-76	15	18¾	30
31	136	55-58	62-65	69-73	77-81	15¾	19⅝	32
33	144½	59-61	66-70	74-78	82-86	16½	21	34
35	153	62-65	71-74	79-83	87-91	17½	22⅝	36
37	161½	66-69	75-78	84-87	92-97	18¼	23¼	38
39	170	70-73	79-82	88-92	98-102	19¼	24½	40
41	178½	74-76	83-87	93-97	103-107	20	25⅝	42
43	187	77-80	88-91	98-102	108-112	21	26⅝	44
45	195	81-84	92-95	103-106	113-118	22	28	46
47	204	85-88	96-99	107-111	119-123	22¾	29¼	48
49	212½	89-91	100-104	112-116	124-128	23¼	30⅝	50
51	221	92-95	105-108	117-121	129-133	24½	31½	52
53	229½	96-99	109-112	122-125	134-139	25½	32⅝	54
55	238	100-103	113-116	126-130	140-144	26½	33¼	56
57	246½	104-106	117-121	131-135	145-149	27½	35	58
59	255	107-110	122-125	136-140	150-154	28¼	36	60
61	263½	111-114	126-129	141-144	155-160	29¼	37¼	62
63	272	115-118	130-133	145-149	161-165	30	38½	64
65	280½	119-121	134-138	150-154	166-170	31	39½	66
67	289	122-125	139-142	155-159	171-175	32	40¼	68
69	297½	126-129	143-146	160-163	176-181	32¾	42	70
71	306	130-133	147-150	164-168	182-186	33¼	43	72
73	314½	134-136	151-155	169-173	187-191	34½	44¼	74
75	323	137-140	156-159	174-178	192-196	35½	45⅝	76
77	331½	141-144	160-163	179-182		36½	46½	78
79	340	145-148	164-167	183-187		37¼	47¼	80
81	348½	149-151	168-172	188-192		38¼	48⅝	82
83	357	152-155	173-176	193-197		39	50	84
85	365½	156-159	177-180			40	51¼	86
87	374	160-163	181-184			41	52⅝	88
89	382½	164-166	185-189			41¾	53½	90
91	391	167-170	190-193			42¾	54⅝	92
93	399½	171-174				43½	55⅝	94
95	408	175-178				44½	57	96
97	416½	179-181				45½	58¼	98
99	425	182-185				46½	59⅝	100
101	433½	186-189				47¼	60½	102
103	442	190-193				48¼	61⅝	104

No. of Full Spaces	** Fabric Width (Hemmed)	PANEL COVERAGE				Stack Back Widths		* No. of Carriers Required
		92140 93140 120%	92141 93141 100%	92142 93142 80%	92143 93143 60%	Std. Snap Carrier	Front Load Carriers	
7	35½	11-14	12-16	14-17	14-19	8	8⅝	8
9	44	15-18	17-20	18-22	20-24	9	9½	10
11	52½	19-21	21-24	23-27	25-30	9¼	10⅝	12
13	61	22-25	25-28	28-32	31-35	10¼	11⅝	14
15	69½	26-29	29-32	33-36	36-40	11½	13	16
17	78	30-33	33-37	37-41	41-45	12½	14	18
19	86½	34-36	38-41	42-46	46-51	13¼	15⅝	20
21	95	37-40	42-45	47-51	52-56	14¼	16⅝	22
23	103½	41-44	46-50	52-55	57-61	15	17½	24
25	112	45-48	51-54	56-60	62-66	16	18½	26
27	120½	49-51	55-58	61-65	67-72	16¾	20	28
29	129	52-55	59-62	66-70	73-77	17¾	21	30
31	137½	56-59	63-66	71-74	78-82	18½	22⅝	32
33	146	60-63	67-71	75-79	83-87	19½	23⅝	34
35	154½	64-66	72-75	80-84	88-93	20¼	24½	36
37	163	67-70	76-79	85-89	94-98	21¼	25½	38
39	171½	71-74	80-84	90-93	99-103	22	26¾	40
41	180	75-78	85-88	94-98	104-108	22¼	28	42
43	188½	79-81	89-92	99-103	109-114	23½	29	44
45	197	82-85	93-96	104-108	115-119	24¼	30⅝	46
47	205½	86-89	97-101	109-112	120-124	25	31¼	48
49	214	90-93	102-105	113-117	125-129	25¾	32½	50
51	222½	94-96	106-109	118-122	130-135	26½	33½	52
53	231	97-100	110-113	123-127	136-140	27¼	34¾	54
55	239½	101-104	114-118	128-131	141-145	28¼	35⅝	56
57	248	105-108	119-122	132-136	146-150	29	37	58
59	256½	109-111	123-126	137-141	151-156	30	38⅝	60
61	265	112-115	127-130	142-146	157-161	31	39¼	62
63	273½	116-119	131-136	147-150	162-166	31¾	40½	64
65	282	120-123	137-139	151-155	167-171	32¾	41½	66
67	290½	124-126	140-143	156-160	172-176	33½	42⅝	68
69	299	127-130	144-147	161-165	177-182	34½	44	70
71	307½	131-134	148-152	166-169	183-187	35¼	45	72
73	316	135-138	153-156	170-174	188-192	36¼	46⅝	74
75	324½	139-141	157-160	175-179		37	47¼	76
77	333	142-145	161-164	180-184		38	48½	78
79	341½	146-149	165-168	185-188		39	49½	80
81	350	150-153	169-173	189-193		39¾	50¼	82
83	358½	154-156	174-177			40¼	52	84
85	367	157-160	178-181			41½	53	86
87	375½	161-164	182-186			42½	54	88
89	384	165-168	187-190			43¼	55¼	90
91	392½	169-171				44¼	56½	92
93	401	172-175				45¼	57½	94
95	409½	176-179				46	58¼	96
97	418	180-183				47	60	98
99	426½	184-186				48	61	100
101	435	187-190				49¼	62	102

*Includes one carrier (button position only) for attachment to master.
**Add 1" if fabricating for 94001 "Architrac."

(When using overlap stiffener for Baton Draw system, use Fabrication Guide F0337018)

Notes

TO PLACE ORDERS,
VERIFY STATUS OR
OBTAIN THE LATEST
PRODUCT INFORMATION
CALL TOLL-FREE:
1-800-817-6344

OR FAX TOLL-FREE:
1-800-308-4293

For express service, have your
customer code readily available.



www.kirsch.com

Kirsch Window Fashions ©2008
4110 Premier Drive, High Point, NC 27265
Phone: 1.800.225.1988 • Fax: 1.800.545.2325
www.kirsch.com

A **NewellRubbermaid** Company

F0337008